



sliding gates



Robus350

Instructions and warnings for the fitter

Istruzioni ed avvertenze per l'installatore

Instructions et recommandations pour l'installateur

Anweisungen und Hinweise für den Installateur

Instrucciones y advertencias para el instalador

Instrukcje i uwagi dla instalatora



COMPANY
WITH QUALITY SYSTEM
CERTIFIED BY DNV
=ISO 9001/2000=

Nice

Robus350

Table of contents:

| | page | | | | |
|--------------|---|----|--------------|--|----|
| 1 | Warnings | 3 | 7 | Additional information | 12 |
| 2 | Product description and applications | 3 | 7.1 | Programming keys | 12 |
| 2.1 | Operating limits | 3 | 7.2 | Programming | 12 |
| 2.2 | Typical system | 4 | 7.2.1 | Level one functions (ON-OFF functions) | 12 |
| 2.3 | List of cables | 4 | 7.2.2 | Level one programming (ON-OFF functions). | 13 |
| 3 | Installation | 4 | 7.2.3 | Level two functions (adjustable parameters) | 13 |
| 3.1 | Preliminary checks | 5 | 7.2.4 | Level two programming (adjustable parameters) | 14 |
| 3.2 | Installation of the gearmotor | 5 | 7.2.5 | Level one programming example (ON-OFF functions). | 14 |
| 3.3 | Installation of the Various Devices | 6 | 7.2.6 | Level two programming example (adjustable parameters) | 15 |
| 3.4 | Electrical connections | 6 | 7.3 | Adding or Removing Devices | 15 |
| 3.5 | Description of the electrical connections | 7 | 7.3.1 | BlueBUS | 15 |
| 4 | Final checks and start up | 7 | 7.3.2 | STOP Input | 15 |
| 4.1 | Choosing the direction | 7 | 7.3.3 | Photocells | 16 |
| 4.2 | Power Supply Connection | 8 | 7.3.4 | Recognition of other devices | 16 |
| 4.3 | Recognition of the devices | 8 | 7.4 | Special Functions | 16 |
| 4.4 | Recognizing the length of the leaf | 8 | 7.4.1 | “Always open” Function | 16 |
| 4.5 | Checking gate movements | 8 | 7.4.2 | “Move anyway” function | 16 |
| 4.6 | Preset functions | 8 | 7.5 | Connection to other devices | 17 |
| 4.7 | Memorization of Radio Transmitters | 9 | 7.6 | Troubleshooting | 17 |
| 4.7.1 | Memorization Mode I | 9 | 7.7 | Diagnostics and Signals | 17 |
| 4.7.2 | Memorization Mode II | 9 | 7.7.1 | Flashing light signalling | 18 |
| 4.7.3 | “Remote” memorization | 10 | 7.7.2 | Signals on the control unit | 18 |
| 4.7.4 | Deleting the Radio Transmitters | 10 | 7.8 | Accessories | 19 |
| 4.7.5 | Declaration of conformity of the radio receiver | 10 | 8 | Technical characteristics | 20 |
| 5 | Testing and commissioning | 10 | | Instructions and Warnings for users of ROBUS gearmotor | 21 |
| 5.1 | Testing | 11 | | | |
| 5.2 | Commissioning | 11 | | | |
| 6 | Maintenance and Disposal | 11 | | | |
| 6.1 | Maintenance | 11 | | | |
| 6.2 | Disposal | 11 | | | |

1) Warnings

This manual contains important information regarding safety. Before you start installing the components, it is important that you read all the information contained herein. Store this manual safely for future use.

Due to the dangers which may arise during both the installation and use of the ROBUS350, installation must be carried out in full respect of the laws, provisions and rules currently in force in order to ensure maximum safety. This chapter provides details of general warnings. Other, more specific warnings are detailed in Chapters “3.1 Preliminary Checks” and “5 Testing and Commissioning”.

⚠ according to the most recent European legislation, the production of automatic doors or gates is governed by the provisions listed in Directive 98/37/CE (Machine Directive) and, more specifically, to provisions: EN 12445, EN 12453 and EN 12635, which enable manufacturers to declare the presumed conformity of the product.

Please access “www.niceforyou.com” for further information, and guidelines for risk analysis and how to draw up the Technical Documentation.

- This manual has been especially written for use by qualified fitters. Except for the enclosed specification “Instructions and Warnings for Users of the ROBUS gearmotor” which is to be removed by the installer, none of the information provided in this manual can be considered as being of interest to end users!
- Any use or operation of ROBUS350 which is not explicitly provided for in these instructions is not permitted. Improper use may cause damage and personal injury.

- Risk analysis must be carried out before starting installation, to include the list of essential safety requisites provided for in Enclosure I of the Machine Directive, indicating the relative solutions employed. N.B. Risk analysis is one of the documents included in the “Technical Documentation” for this automation.
- Check whether additional devices are needed to complete the automation with ROBUS350 based on the specific application requirements and dangers present. The following risks must be considered: impact, crushing, shearing, dragging, etc. as well as other general dangers.
- Do not modify any components unless such action is specified in this manual. Operations of this type are likely to lead to malfunctions. NICE disclaims any liability for damage resulting from modified products.
- During installation and use, ensure that solid objects or liquids do not penetrate inside the control unit or other open devices. If necessary, please contact the NICE customer service department; the use of ROBUS350 in these conditions can be dangerous.
- The automation system must not be used until it has been commissioned as described in chapter 5: “Testing and commissioning”.
- The packing materials of ROBUS350 must be disposed of in compliance with local regulations.
- If a fault occurs that cannot be solved using the information provided in this manual, refer to the NICE customer service department.
- In the event that any automatic switches are tripped or fuses blown, you must identify the fault and eliminate it before resetting the switches or replacing fuses.
- Disconnect all the power supply circuits before accessing the terminals inside the ROBUS350 cover. If the disconnection device is not identifiable, post the following sign on it: “WARNING: MAINTENANCE WORK IN PROGRESS”.

2) Product description and applications

ROBUS350 is an electromechanical gearmotor used to automate sliding gates for residential use. It has an electronic control unit and receiver for radio control devices. The electrical connections to external devices have been simplified through the use of “BlueBUS”, a technique by which several devices can be connected up using just 2 wires.

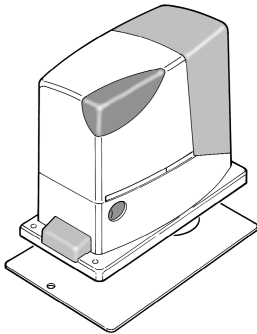

1

ROBUS350 operates with electric power. In the event of a power failure, the gearmotor can be released using a special key in order to move the gate manually. Alternatively, there is the PS124 buffer battery (optional accessory) which makes it possible to use the gate also during the event of a power failure.

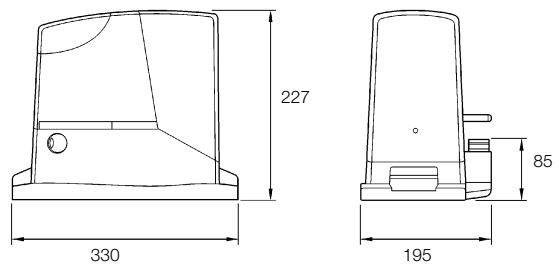

2.1) Operating limits

Chapter 8 “Technical Characteristics” provides the data needed to determine whether ROBUS350 components are suitable for the intended application.

In general, ROBUS350 is suitable for the automation of gates with leaves up to 15 m wide and weighing max 350 kg, as shown in Tables 1 and 2.

The length of the leaf makes it possible to determine both the maximum number of cycles per hour and consecutive cycles, while the weight makes it possible to determine the reduction percentage of the cycles and the maximum speed allowed. For example, if the leaf is 5m long it will be possible to have 10 cycles/hour and 6 consecutive cycles. However, if the leaf weighs 240Kg, they must be reduced to 80%, resulting in 8 cycles/hour and approximately 5 consecutive cycles, while the maximum speed allowed is V5: very fast.

The control unit has a limiting device which prevents the risk of overheating based on the load of the motor and duration of the cycles. This device triggers when the maximum limit is exceeded.

Table 1: limits in relation to the length of the leaf.

| Length of leaf m | max. cycles/hour | max. no. of consecutive cycles |
|------------------|------------------|--------------------------------|
| Max. 3 | 30 | 20 |
| 3÷5 | 18 | 12 |
| 5÷6 | 15 | 10 |
| 6÷7 | 12 | 8 |

Table 2: limits in relation to the weight of the leaf

| Leaf weight Kg. | Percentage cycles | Maximum speed allowed |
|-----------------|-------------------|-----------------------|
| Max. 200 | 100% | V6 = extremely fast |
| 200÷250 | 90% | V5 = very fast. |
| 250÷300 | 80% | V4 = fast |
| 300÷350 | 70% | V3 = medium |

2.2) Typical system

Figure 2 shows a typical system for automating a sliding gate using ROBUS350.

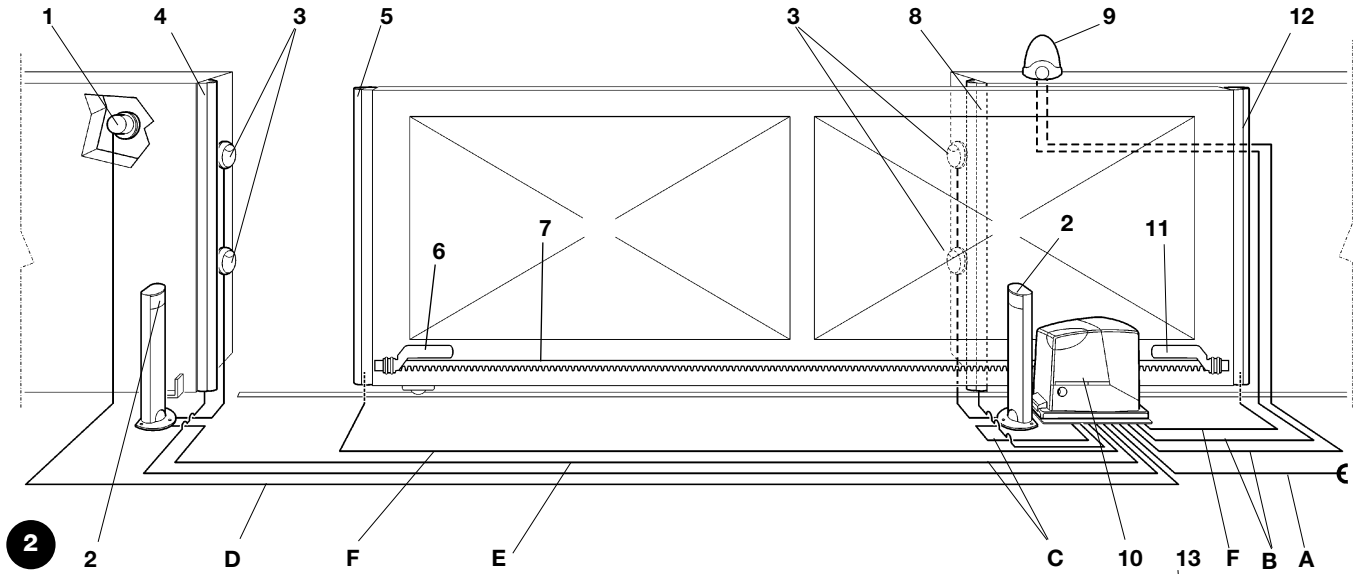

- | | |
|--------------------------------|---|
| 1 Key-operated selector switch | 8 Secondary fixed edge (optional) |
| 2 Photocells on post | 9 flashing light with incorporated aerial |
| 3 Photocells | 10 ROBUS350 |
| 4 Main fixed edge (optional) | 11 "Closed" stop bracket |
| 5 Main movable edge | 12 Secondary movable edge (option) |
| 6 "Open" stop bracket | 13 Radio-transmitter |
| 7 Rack | |

2.3) List of cables

Figure 1 shows the cables needed for the connection of the devices in a typical installation; Table 2 shows the cable characteristics.

⚠: the cables used must be suitable for the type of installation. For example, an H03VV-F type cable is recommended for indoor applications, while an H07RN-F is suitable for outdoor applications.

Table 3: list of cables

| Connection | Cable type | Maximum length allowed |
|--|--|--------------------------------|
| A: Power line | N°1 3x1.5mm ² cable | 30m (note 1) |
| B: Flashing light with aerial | N°1 2x0.5mm ² cable | 20m |
| | N°1 RG58 type shielded cable | 20m (recommended less than 5m) |
| C: Photocells | N°1 2x0.5mm ² cable | 30m (note 2) |
| D: Key-operated selector switch | N°2 2x0.5mm ² cables (note 3) | 50m |
| E: Fixed edges | N°1 2x0.5mm ² cable (note 4) | 30m |
| F: Movable edges | N°1 2x0.5mm ² cable (note 4) | 30m (note 5) |

Note 1: power supply cables longer than 30 m may be used provided they have a larger gauge, e.g. 3x2.5mm², and a safety grounding system is provided near the automation unit.

Note 2: A 2x1mm² cable is needed if the "BLUEBUS" cable is longer than 30 m (max. 50 m).

Note 3: A single 4x0.5mm² cable can be used instead of two 2x0.5mm² cables.

Note 4: Please refer to Chapter "7.3.2 STOP Input" in situations where there is more than one edge, for information about the type of connection recommended by the manufacturers.

Note 5: special devices which enable connection even when the leaf is moving must be used to connect movable edges to sliding leaves.

3) Installation

⚠ The installation of ROBUS350 must be carried out by qualified personnel in compliance with current legislation, standards and regulations, and the directions provided in this manual

3.1) Preliminary checks

Before proceeding with the installation of ROBUS350 you must:

- Check that all the materials are in excellent condition, suitable for use and that they conform to the standards currently in force. .
- Make sure that the structure of the gate is suitable for automation.
- Make sure that the weight and dimensions of the leaf fall within the specified operating limits provided in chapter "2.1 Operating limits".
- Check that the static friction (that is, the force required to start the movement of the leaf) is less than half the "maximum torque", and that the dynamic friction (that is, the force required to keep the leaf in movement) is less than half the "nominal torque". Compare the resulting values with those specified in Chapter "8 Technical Characteristics". The manufacturers recommend a 50% margin on the force, as unfavourable climatic conditions may cause an increase in the friction.
- Make sure that there are no points of greater friction in the opening or closing travel of the gate leaves.
- Make sure there is no danger of the gate derailing.
- Make sure that the mechanical stops are sturdy enough, and that there is no risk of deformation even when the leaf hits the mechanical stop violently.
- Make sure that the gate is well balanced. It must not move by itself when it is placed in any position.
- Make sure there is no risk of flooding in the area the gearmotor is fixed to. Mount the gearmotor raised from the ground if necessary.

- Make sure that the installation area enables the release of the gearmotor and that it is safe and easy to release it
- Make sure that the mounting positions of the various devices are protected from impacts and that the mounting surfaces are sufficiently sturdy.
- Never immerse components in water or other liquids.
- Keep ROBUS350 away from sources of heat and open flames and acid, saline or potentially explosive atmospheres. Situations such as these could damage ROBUS 350 and cause either malfunctions or dangerous situations.
- If there is an access door in the leaf, or a within the range of movement of the gate, make sure that it does not obstruct normal travel. Mount a suitable interblock system if necessary.
- Only connect the control unit to a power supply line equipped with a safety grounding system.
- The power supply line must be protected by suitable magneto-thermal and differential switches.
- A disconnection device must be inserted in the power supply line from the electrical mains (the distance between the contacts must be at least 3.5mm with an overvoltage category of III) or equivalent system, for example an outlet and relative plug. If the disconnection device for the power supply is not mounted near the automation, it must have a locking system to prevent unintentional, unauthorised connection.

3.2) Installation of the gearmotor

The gearmotor must be fastened directly to an already existing mounting surface using suitable means, for example expansion screw anchors. Otherwise, in order to fasten the gearmotor the installer must:

1. Dig a foundation hole with suitable dimensions referring to Figure 3.
2. Prepare one or more conduits for the electrical cables as shown in Figure 4
3. Assemble the two clamps on the foundation plate setting one nut underneath and one on top of the plate. The nut underneath the plate must be screwed to the end of the thread so that the threaded part protrudes above the plate by approximately 25÷35 mm.

4. Pour the concrete and, before it starts to harden, set the foundation plate to the values shown in Figure 3. Check that it is parallel to the leaf and perfectly level. Wait for the concrete to harden completely.
5. Remove the 2 upper nuts of the plate and then place the gearmotor onto them. Check that it is perfectly parallel to the leaf, then screw the two nuts and washers supplied, as shown in Figure 7.

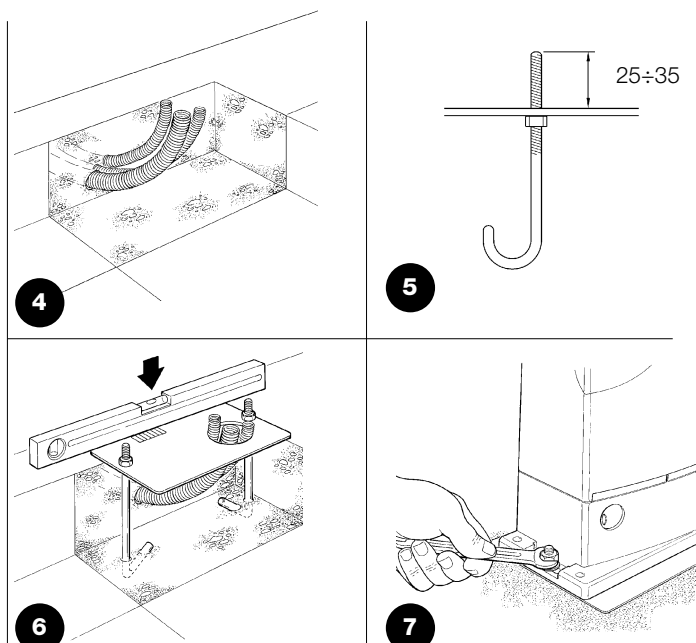
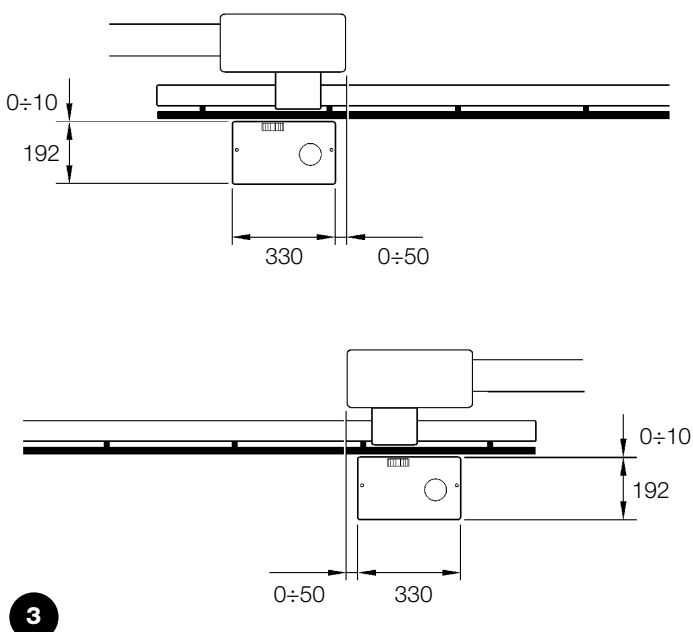

If the rack is already present, once the gearmotor has been fastened use the adjustment dowels as shown in Figure 8 to set the pinion of ROBUS350 to the right height, leaving $1\pm 2\text{mm}$ of play from the rack. Otherwise, the installer must carry out the following procedure in order to fasten the rack:

6. Release the gearmotor as shown in the “Release and manual movement” paragraph in the Chapter “Instructions and Warnings for users of the ROBUS gearmotor”

7. Open the leaf up completely and place the first piece of the rack on the pinion. Check that the beginning of the rack corresponds to the beginning of the leaf, as shown in Figure 9. Leave a $1\pm 2\text{mm}$ play between the rack and the pinion, then fasten the rack to the leaf using suitable means.

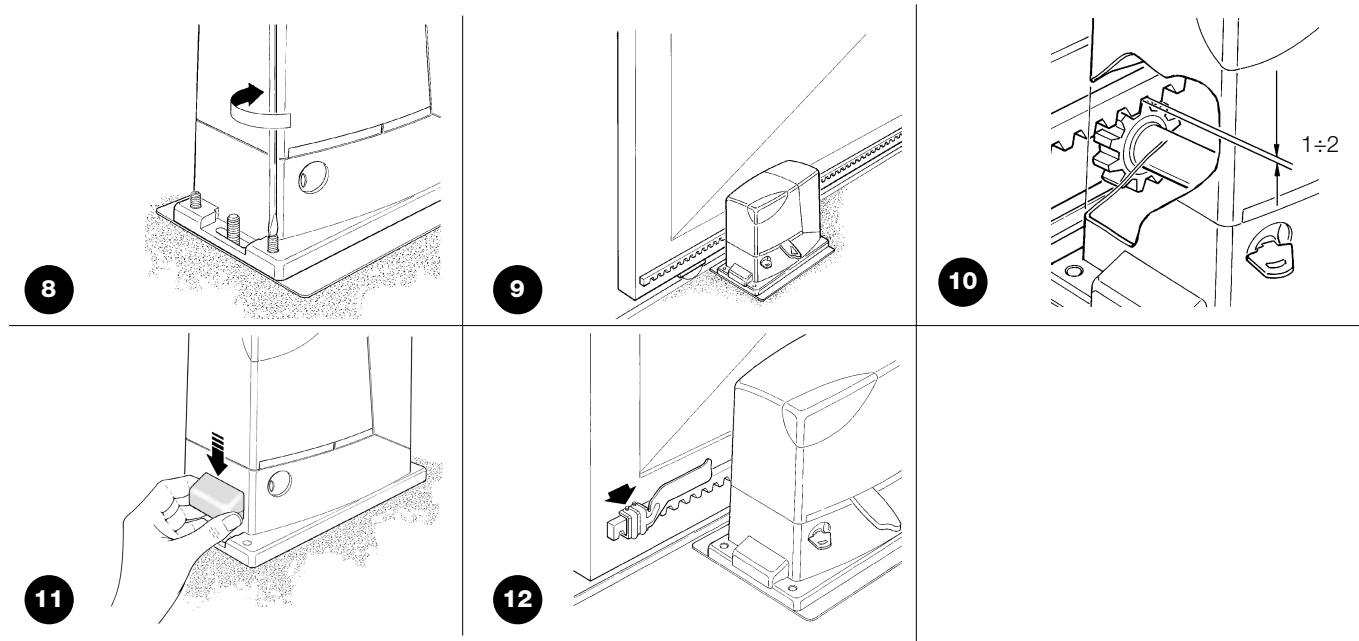

⚠ In order to prevent the weight of the leaf from affecting the gearmotor, it is important that there is a play of $1\pm 2\text{mm}$ between the rack and the pinion as shown in Figure 10.

- 8.** Slide the leaf, using the pinion as a reference point for the fastening the other elements of the rack.
- 9.** Cut away any excess of the rack.
- 10.** Open and close the gate several times and make sure that the rack is aligned with the pinion with a maximum tolerance of 5mm. Moreover, check that the play of $1\pm 2\text{mm}$ has been respected along the entire length between the pinion and the rack.

11. Thoroughly tighten the two fixing nuts of the gearmotor, making sure it is well fastened to the ground. Cover the fixing nuts with the relative caps as shown in figure 11.

12. Fix the two “Opening” and “Closing” limit switch brackets with the relative dowels to the outer sides of the rack as shown in Figure 12. Consider that the leaf will slide for about another $2\pm 3\text{cm}$ after the limit switch cuts in. The brackets should be positioned at a sufficient distance from the mechanical stops.

13. Lock the gearmotor as shown in the “Release and manual movement” paragraph in the Chapter “Instructions and Warnings for Users of the ROBUS gearmotor”

3.3) Installation of the Various Devices

If other devices are needed, install them following the directions provided in the corresponding instructions. Check this in paragraph “3.5 Description of electrical connections” and the devices which can be connected to the ROBUS350 in Figure 2.

3.4) Electrical connections

⚠ Only carry out electrical connections once the electricity supply to the system has been switched off. Disconnect any buffer batteries present.

- 1.** Remove the protection cover in order to access the electronic control unit of the ROBUS350. The side screw must be removed, and the cover lifted upwards.
- 2.** Remove the rubber membrane which closes the hole for passage of the cables and insert all the connection cables towards the various devices, leaving a length of $20\pm 30\text{cm}$ longer than necessary. See Table 3 for information regarding the type of cables and Figure 2 for the connections.
- 3.** Use a clamp to collect together and join the cables which enter the gearmotor. Place the clamp just underneath the hole the cables enter through. Make a hole in the rubber membrane which

is slightly smaller than the diameter of the cables which have been collected together, and insert the membrane along the cables until you reach the clamp. Then put the membrane back in the slot of the hole the cables pass through. Lay a second clamp for collecting the cables which are set just above the membrane.

- 4.** Connect the power cable to the appropriate terminal as shown in Figure 13, then block the cable at the first cable block ring using the clamp.
- 5.** Connect up the other cables according to the diagram in Figure 15. The terminals can be removed in order to make this work easier.
- 6.** Once the connections have been completed, block the cables collected in the second cable block ring using clamps. The excess of the antenna cable must be blocked to the other cables using another clamp as shown in Figure 14.

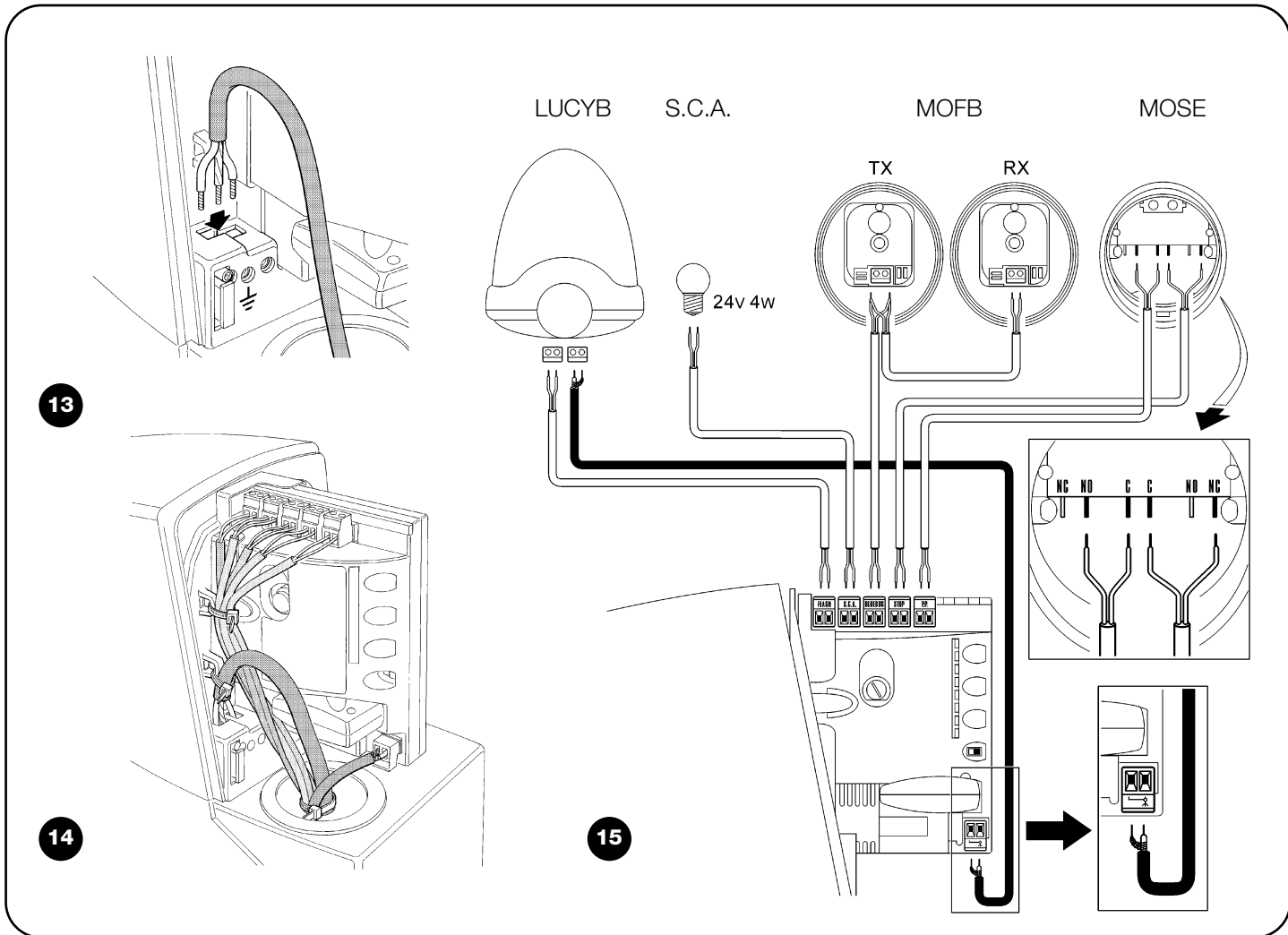

3.5) Description of the electrical connections

Here follows a brief description of the electrical connections. Please refer to the “7.3. Adding or Removing Devices” paragraph for further information.

FLASH: flashing light output “LUCYB” type or similar outputs with a single 12V lamp, max. 21 W.

S.C.A.: “Open Gate Light” output. An indication lamp can be connected (24V max. 4W).

BLUEBUS: compatible devices can be connected up to this terminal. They are connected in parallel using two conductors only, through which both the electricity supply and the communication signals travel. Please refer to paragraph “7.3.1BlueBUS” for further information about BlueBUS.

STOP: input for the devices which block or eventually stop the manoeuvre in progress. Contacts like “Normally Closed”, “Normally Open” or constant resistance devices can be connected up using special procedures on the input. Please refer to Paragraph “7.3.2 STOP Input” for further information about STOP.

P.P.: input for devices which control movement. It is possible to connect “Normally Open” devices up to this input.

ANTENNA: connection input for the radio receiver aerial (the aerial is incorporated in LUCY B).

4) Final checks and start up

The manufacturers recommend you position the leaf at approximately half travel before starting the checking and start up phase of the automation. This will ensure the leaf is free to move both during opening and closure.

4.1) Choosing the direction

The direction of the opening manoeuvre must be chosen depending on the position of the gearmotor with respect to the leaf. If the leaf must move left for opening, the selector must be moved towards left as shown in Figure 16; alternatively, if the leaf has to move right during opening, the selector must be moved towards the right as shown in Figure 17.

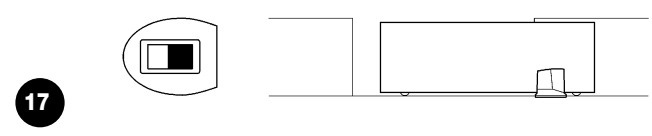
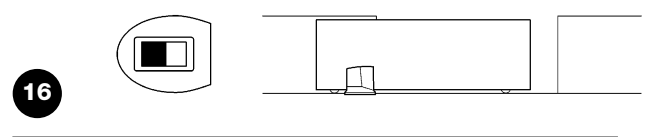

4.2) Power Supply Connection

⚠ The connection of ROBUS350 to the mains must be made by qualified and experienced personnel in possession of the necessary requisites and in full respect of the laws, provisions and standards currently in force.

As soon as ROBUS350 is energized, you should check the following:

1. Make sure that the "BLUEBUS" LED flashes regularly, with about one flash per second
2. Make sure that the LED's on the photocells flash (both on TX and RX); the type of flashing is not important as it depends on other factors.
3. Make sure that the flashing light connected to the FLASH output

and the lamp LED connected to the "Open Gate Indicator" output are off.

If the above conditions are not satisfied, you should immediately switch off the power supply to the control unit and check the electrical connections more carefully.

Please refer to Chapter "7.6 Troubleshooting" for further information about finding and analysing failures.

4.3) Recognition of the devices

After connecting up the power supply, the control unit must be made to recognise the devices connected up to the BLUEBUS and

STOP inputs. Before this phase, LEDs L1 and L2 will flash to indicate that recognition of the devices must be carried out.

1. Press keys **[▲]** and **[Set]** and keep them pressed down
2. Release the keys then LEDs L1 and L2 start flashing rapidly (after approx. 3 sec.)
3. Wait for a few seconds for the control unit to finish recognising the devices
4. STOP LED must remain on when the recognitions stage has been completed, while LEDs L1 and L2 will switch off (LEDs L3 and L4 will eventually start flashing).

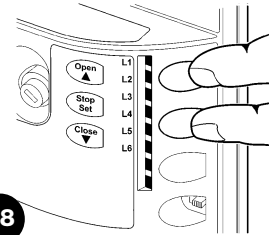

The connected devices recognition stage can be repeated at any time, even after installation, e.g. if another device is added. Please refer to

Paragraph "7.3.4 Recognition of other devices" for information about how to carry out another recognition process.

4.4) Recognizing the length of the leaf

After recognizing the devices, LEDs L3 and L4 will start flashing. This means that the control unit must be made to recognize the length of the leaf. During this stage, the length of the leaf is measured from the

closing limit switch to the opening limit switch. This measurement is required to calculate the deceleration points and the partial opening point.

1. Press keys **[▼]** and **[Set]** and keep them pressed down.
2. Release the keys when the manoeuvre starts (after approx. 3 s)
3. Check the manoeuvre in progress is an opening manoeuvre. Otherwise, press the [Stop] key and carefully check Paragraph "4.1 Choosing the Direction", then repeat the process from Point 1.
4. Wait for the control unit to open the gate until it reaches the opening limit switch. The closing manoeuvre will start immediately afterwards.
5. Wait for the control unit to close the gate.

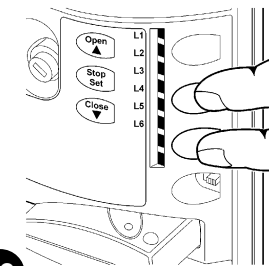

If the above conditions are not satisfied, you should immediately switch off the power supply to the control unit and check the electri-

cal connections more carefully. Please refer to Paragraph "7.6 Troubleshooting" for further information.

4.5) Checking gate movements

On completion of the recognition of the length of the leaf, it is advisable to carry out a number of manoeuvres in order to check the gate travels properly.

1. Press the **[Open]** key to open the gate. Check that gate opening occurs regularly, without any variations in speed. The leaf must only slowdown and stop when it is between 70 and 50 cm from the opening mechanical stop. Then, at 2÷3cm from the mechanical opening stop the limit switch will trigger.
2. Press the **[Close]** key to close the gate. Check that the gate closes regularly without any variations in speed. The leaf must only slowdown and stop when it is between 70 and 50 cm from the closing mechanical stop. Then, at 2÷3cm from the mechanical closing stop the limit

switch will trigger.

3. During the manoeuvre, check that the flashing light flashes at a speed of 0.5 seconds on and 0.5 seconds off. If present, also check the flashes of the light connected to the S.C.A. terminal: slow flashes during opening, quick flashes during closing.
4. Open and close the gate several times to make sure that there are neither points of excessive friction nor defects in the assembly or adjustments.
5. Check that the fastening of the ROBUS350 gearmotor, the rack and the limit switch brackets are solid, stable and suitably resistant, even if the gate accelerates or decelerates sharply.

4.6) Preset functions

The ROBUS350 control unit has a number of programmable functions. These functions are set to a configuration which should satisfy most automations. However, the functions can be altered at any time by means of a special programming procedure. Please refer to paragraph

"7.2 Programming" for further information about this.

4.7) Memorization of Radio Transmitters

The "SM" radio receiver connector for SMXI or SMXIS type radio receivers has been provided in order to enable the user to control ROBUS350 from a distance (see Figure 18). Each radio transmitter is recognised by the said receiver by means of a "code" which is different from that of any other transmitter. It is thus necessary to carry out the "memorisation" procedure by means of which the user prepares the receiver to recognise each single transmitter. Transmitters can be memorised in 2 modes:

Mode I: in this mode the function of the transmitter keys is fixed and each key corresponds to the command in the control unit shown in Table 4. A single stage is carried out for each transmitter, during which all the transmitter keys are memorised. It does not matter which key is pressed during this stage and only one place in the memory is used. A transmitter can normally only control a single automation in Mode I

Mode II: in this mode, each transmitter key can be associated with one of the 4 possible control unit commands shown in Table 5. Only one key is memorised for each stage, namely the one which was pressed during memorisation. One place in the memory is occupied for each key memorised.

In Mode II, different keys on the same transmitter can be used in order to give the same automation more than one command or to control more than one automation. For example, in Table 6, only automation "A" is controlled, and the T3 and T4 keys are associated with the same command. Alternatively, three automations are controlled in the example shown in Table 7, namely "A" (keys T1 and T2), "B" (key T3) and "C" (key T4).

⚠ since the memorization procedures are timed (10s), you must read the instructions in the following paragraphs before you proceed with their execution

Table 4: Mode I memorisation

| | |
|--------|---------------------------|
| T1 key | "Step-by-step" command |
| T2 key | "Pedestrian gate" command |
| T3 key | "Open" command |
| T4 key | "Close" command |

Note: single-channel transmitters only have a T1 key, two channel transmitters only have T1 and T2 keys.

Table 5: commands available in Mode II

| | |
|-----|---------------------------|
| N°1 | "Step-by-step" command |
| N°2 | "Pedestrian gate" command |
| N°3 | "Open" command |
| N°4 | "Close" command |

Table 6: 1st example of memorization in Mode II

| | | |
|--------|---------------------------|--------------|
| T1 key | "Open" command | Automation A |
| T2 key | "Close" command | Automation A |
| T3 key | "Pedestrian Gate" command | Automation A |
| T4 key | "Pedestrian Gate" command | Automation A |

Table 7: 2nd example of memorization in Mode II

| | | |
|--------|------------------------|--------------|
| T1 key | "Open" command | Automation A |
| T2 key | "Close" command | Automation A |
| T3 key | "Step-by-step" command | Automation B |
| T4 key | "Step-by-step" command | Automation C |

4.7.1) Memorization Mode I

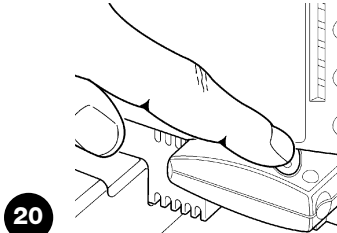

Table 8: to memorize a transmitter in mode I

| | Example |
|--|---------|
| 1. Press the key on the receiver and hold it down (approx. 3 s) | 3s |
| 2. Release the key when the LED on the receiver lights up | |
| 3. Within 10s, press any key on the radio transmitter to be memorized and hold it down for at least 2s | 2s |
| 4. If the memorization procedure is successful, the LED on the receiver will flash 3 times. | x3 |

If there are other transmitters to be memorized, repeat step 3 within the next 10 s, otherwise the memorization stage will terminate automatically.

4.7.2) Memorization Mode II

Table 9: to memorize the key of a transmitter in mode II

| | Example |
|---|---------|
| 1. Press the key on the receiver as many times as the number corresponding to the desired command, according to table 5 | 1...4 |
| 2. Make sure that the LED on the receiver makes as many flashes as the number corresponding to the selected command | 1...4 |
| 3. Within 10 s, press any key on the radio transmitter to be memorized and hold it down for at least 2 s | 2s |
| 4. The LED on the receiver will flash 3 times if the memorization procedure has been successful | x3 |



If there are other transmitters to be memorized for the same type of command, repeat step 3 within the next 10 s, otherwise the memorization stage will terminate automatically.

4.7.3) “Remote” memorization

A new radio transmitter can be memorized without directly operating the keys on the receiver. You need to have a pre-memorized operational radio transmitter. The “new” radio transmitter will inherit the characteristics of the old one, i.e. if the old radio transmitter was memorized in Mode 1, the new one will also be memorized in Mode 1. In this case, during the memorization stage you can press any key on the two transmitters. If, on the other hand, the old transmitter was memorized in Mode II, the new one will also be memorized in Mode II: you must press the key on the old transmitter which corresponds to the desired command, and the key on the new transmitter to which you wish to associate that command





⚠ remote memorisation can occur in all those receivers which are within range of the capacity of the transmitter. Therefore, only the one which is actually involved in the operation must be powered.

Holding the two transmitters, position yourself within the operating range of the automation and perform the following operations:

| Table 10: for the “Remote” memorization of a transmitter | Example |
|---|---|
| 1. Press the key on the new radio transmitter and hold it down for at least 5 s, then release it. |  |
| 2. Press key on the previously memorized transmitter slowly 3 times. |  |
| 3. Press the key on the new radio transmitter once slowly. |  |

At this point the new radio transmitter will be recognized by the receiver and will assume the characteristics of the previously memorized one. If there are other transmitters to be memorized, repeat all the steps above for each new transmitter.

4.7.4) Deleting the Radio Transmitters

| Table 11: to delete all the radio transmitters | Example |
|--|---|
| 1. Press the key on the receiver and hold it down |  |
| 2. Wait until the LED lights up, then wait until it goes off, then wait until it has flashed 3 times |  |
| 3. Release the key precisely upon the third flash. |  |
| 4. If the procedure is successful, after a few moments the LED will flash 5 times. |  |

4.7.5) Declaration of conformity of the radio receiver

Declaration of conformity

N°: 151/SMXI Rev03
 Nice S.p.a., Via Pezza Alta 13, 31046 Rustignè di Oderzo (TV) Italy
 NICE S.p.a. declares that radio receiver models SMXI, SMXIS and the relative FLO2R-S and SM2 transmitters conform to the essential requirements specified in Directive R&TTE 1999/5/CE, for the use the devices have been manufactured for. Manufactured in Class 1, Sub-class 20.
 Fabbricato in Classe 1, Sub-classe 20

Date 19th March 2004

Managing Director
 Lauro Buoro

5) Testing and commissioning

This is the most important stage in the automation system installation procedure in order to ensure the maximum safety levels. Testing can also be adopted as a method of periodically checking that all the various devices in the system are functioning correctly.

⚠ Testing of the entire system must be performed by qualified and experienced personnel who must establish which tests to conduct on the basis of the risks involved, and verify the compliance of the system with applicable regulations, legislation and standards, in particular with all the provisions of EN standard 12445 which establishes the test methods for automation systems for gates

5.1) Testing

Each component of the system, e.g. safety edges, photocells, emergency stop, etc. requires a specific testing phase. We therefore recommend observing the procedures shown in the relative instruction manuals.

To test ROBUS 350 proceed as follows:

1. Ensure that the instructions outlined in this manual and in particular in chapter 1 "Warnings" have been observed in full;
2. Using the control or stop devices (key-operated selector switch, control keys or radio transmitter) test the opening, closing and stopping of the gate and make sure that the leaves move in the intended direction.
3. Check the proper operation of all the safety devices, one by one (photocells, sensitive edges, emergency stop, etc.). In particular, each time a device is activated the "BLUBUS" LED on the control unit flashes 2 times quickly, confirming that the control unit recognizes the event.
4. To check the photocells and make sure that there is no interference with other devices, pass a 5 cm diameter, 30 cm long cylinder on the optical axis, first near TX, then near RX and finally at the mid-point between them and make sure that in all these cases the device is triggered, switching from the active to the alarm status and vice-versa; finally, that it causes the intended action in the control unit, for example that it causes the reversal of the movement during the closing manoeuvre.
5. If the dangerous situations caused by the movement of the leaf have been safeguarded by limiting the force of impact, the user must measure the impact force according to EN Standard 12445. If the adjustment of the "speed" and control of the "motor force" are used to assist the system for the reduction of the impact force, try to find the adjustment that gives the best results.

5.2) Commissioning

Commissioning can take place only after all the testing phases of the ROBUS350 and the other devices have been terminated successfully. It is not permissible to execute partial commissioning or to enable use of the system in makeshift conditions.

1. Prepare and store for at least 10 years the technical documentation for the automation, which must include at least: assembly drawing of the automation, wiring diagram, analysis of hazards and solutions adopted, manufacturer's declaration of conformity of all the devices installed (for ROBUS350 use the annexed CE declaration of conformity); copy of the instruction manual and maintenance schedule of the automation.
2. Post a label on the gate providing at least the following data: type of automation, name and address of manufacturer (person responsible for the "commissioning"), serial number, year of manufacture and "CE" marking.
3. Post a permanent label or sign near the gate detailing the operations for the release and manual manoeuvre.
4. Prepare the declaration of conformity of the automation system and deliver it to the owner.
5. Prepare the "Installation instructions and warnings" of the automation system and deliver it to the owner.
6. Prepare the maintenance schedule of the automation system and deliver it to the owner; it must provide all directions regarding the maintenance of the single automation devices.
7. Before commissioning the automation system inform the owner in writing regarding dangers and hazards that are still existing (e.g. in the "Installation instructions and warnings").

6) Maintenance and Disposal

This charter provides information about how to draw up a maintenance schedule, and the disposal of ROBUS350

6.1) Maintenance

The automation must be subjected to maintenance work on a regular basis, in order to guarantee it lasts.

⚠ The maintenance operations must be performed in strict compliance with the safety directions provided in this manual and according to the applicable legislation and standards.

If other devices are present, follow the directions provided in the corresponding maintenance schedule.

1. ROBUS350 requires scheduled maintenance work every 6 months or 10,000 manoeuvres (max.) after previous maintenance:
2. Disconnect the power supply (and buffer batteries, if featured)
3. Check for any deterioration of the components which form the automation, paying particular attention to erosion or oxidation of the structural parts. Replace any parts which are below the required standard.
4. Check the wear and tear on the moving parts: pinion, rack and the leaf components; if necessary replace them.
5. Connect the electric power sources up again, and carry out the testing and checks provided for in Paragraph "5.1 Testing".

6.2) Disposal

ROBUS is constructed of various types of materials, some of which can be recycled: steel, aluminium, plastic, electric cables; while others must be disposed of (batteries and electronic boards).

⚠ some electronic components and the batteries may contain polluting substances; do not pollute the environment. Enquire about the recycling or disposal systems available in compliance regulations locally in force.

1. Disconnect the power supply of the automation system (and the buffer battery, if featured).
2. Disassemble all the devices and accessories, following in reverse order the procedures described in chapter 3 "Installation".
3. Wherever possible, separate any parts which can or must be recycled or disposed of in different ways, e.g. metal parts must be disposed of separately from plastic ones, as must the electronic cards, batteries etc.
4. Sort the various materials and consign them to local licensed firms for recovery and disposal.

7) Additional information

Programming, personalisation and how to look for and deal with faults on the ROBUS350 will be dealt with in this chapter.

7.1) Programming keys

The ROBUS350 control unit feature three keys that can be used to command the control unit both during tests and programming.

| | |
|-------------------|--|
| Open ▲ | The "OPEN" key enables the user to control the opening of the gate or move the programming point upwards. |
| Stop Set | The "STOP" key enables the user to stop the manoeuvre. If pressed down for more than 5 seconds it enables the user to enter programming. |
| Close ▼ | The "CLOSE" key enables the user to control the closing of the gate or move the programming point downwards. |

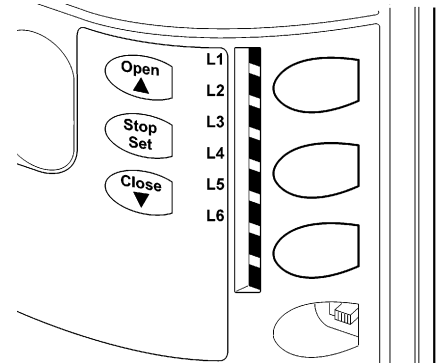

21

7.2) Programming

A number of programmable functions are available on the ROBUS350 control unit. The functions are adjusted using 3 keys set on the control unit: [▲] [Set] [▼] and are used by means of 6 LEDs: L1....L6

The programmable functions available on ROBUS 350 are set out on 2 levels:

Level one: the functions can be adjusted in modes ON-OFF (active or inactive). In this case, each of the LEDs L1....L6 indicates a function. If the LED is on, the function is active, if off the function is inactive. See Table 12

Level two: the parameters can be adjusted on a scale of values (from 1 to 6). In this case, each of the LEDs L1....L6 indicates the value set (there are 6 possible settings). Please refer to Table 14.

7.2.1) Level one functions (ON-OFF functions).

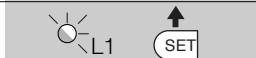



Table 12: list of programmable functions: Level one

| Led | Function | Description |
|-----|-------------------|--|
| L1 | Automatic Closing | This function causes the gate to close automatically after the programmed time has lapsed. The factory set Pause Time is 30 seconds, but can be changed to 5, 15, 30, 45, 60 or 80 seconds. If the function is inactive, functioning will be "semi-automatic". |
| L2 | Close After Photo | This function means it is possible to close the gate 5 seconds after the photocells have disengaged, even if the pause time is set to a higher value. Functioning varies according to whether "Automatic Closing" is active or inactive. When "Automatic Closing" is active, the opening manoeuvre stops immediately after the photocells have disengaged. After 5 seconds, the gate will begin to close. When "Automatic Closing" is inactive the opening manoeuvre will not be interrupted but, when the photocell disengages, this will cause a closing manoeuvre after 5 seconds. If the function is inactive, the pause time will be the one which has been programmed. |
| L3 | Always Close | The "Always Close" function will trigger, and the gate will close if an open gate is detected when the power supply returns. A light will flash for 5 seconds before the manoeuvre starts for reasons of safety. If the function is inactive when the power supply returns, the gate will remain still. |
| L4 | Stand-By | This function enables the user to lower consumption to a very minimum. It is particularly useful in cases when the buffer battery is being used. If this function is active, the control unit will switch the BLUEBUS output (and consequently the devices) and all the LEDs off one minute after the end of the manoeuvre. The only LED which will remain on is the BLUEBUS LED which will simply flash more slowly. When a command arrives, the control unit will reset to complete functioning. If this function is inactive, there will be no reduction in the consumption. |
| L5 | Peak | If this function is activated, the gradual acceleration at the beginning of each manoeuvre will be disconnected. It enables the peak thrust and is useful whenever static friction is high, e.g. if snow or ice are blocking the leaf. If the thrust is inactive, the manoeuvre will start with a gradual acceleration. |
| L6 | Pre-flashing | With the pre-flashing function, a 3 second pause is added between the flashing light switching on and the beginning of the manoeuvre in order to warn the user, in advance, of a potentially dangerous situation. If pre-flashing is inactive, the flashing light will switch on when the manoeuvre starts. |

During the normal functioning of the ROBUS350, LEDs L1....L6 will either be on or off depending on the state of the function they represent. For example, L1 will be on if the "Automatic Closing" function is active.

7.2.2 Level one programming (ON-OFF functions).

Level 1 functions are all factory set to "OFF". However, they can be changed at any time as shown in Table 13. Follow the procedure carefully, as there is a maximum time of 10 seconds between pressing one key and another. If a longer period of time lapses, the procedure will finish automatically and memorize the modifications made up to that stage.

| Table 13: changing ON-OFF functions | | Example |
|-------------------------------------|---|---|
| 1. | Press the key [Set] and hold it down (approx. 3 s) |  |
| 2. | Release the [Set] key when L1 LED starts flashing |  |
| 3. | Press keys [▲] or [▼] to move the flashing LED onto the LED representing the function which is to be changed. |  |
| 4. | Press the [Set] key to change the state of the function (short flashing = OFF; long flashing = ON) |  |
| 5. | Wait 10 seconds before leaving the programme to allow the maximum time to lapse. |  |

Note: Points 3 and 4 can be repeated during the same programming phases in order to set other functions to ON or OFF.

7.2.3 Level two functions (adjustable parameters)

| Table 14: programmable function list: level two | | | | |
|---|----------------------------|-------------|-------------------------------|--|
| Input LED | Parameter | LED (level) | value | Description |
| L1 | Pause Time | L1 | 5 seconds | Adjusts the pause time, namely the time which lapses before automatic closure. This will only have an effect if automatic closing is active. |
| | | L2 | 15 seconds | |
| | | L3 | 30 seconds | |
| | | L4 | 45 seconds | |
| | | L5 | 60 seconds | |
| | | L6 | 80 seconds | |
| L2 | Step-by-step Function | L1 | Open – stop – close - stop | Manages the sequence of controls associated to the Step-by-Step input or to the 1st radio command (see tables 4 and 5). |
| | | L2 | Open – stop – close - close | |
| | | L3 | Open – close – open - close | |
| | | L4 | Condominium operation | |
| | | L5 | Close | |
| | | L6 | Man present | |
| L3 | Motor speed | L1 | Very slow | Adjusts the speed of the motor during normal travel. |
| | | L2 | Slow | |
| | | L3 | Medium | |
| | | L4 | Fast | |
| | | L5 | Very fast | |
| | | L6 | Extremely Fast | |
| L4 | Open Gate Indicator Output | L1 | Open Gate Indicator Function | Adjusts the function associated with the S.C.A. output. |
| | | L2 | On if the leaf is close | |
| | | L3 | On if the leaf is open | |
| | | L4 | Active with 2nd radio command | |
| | | L5 | Active with 3rd radio command | |
| | | L6 | Active with 4th radio command | |
| L5 | Motor force | L1 | "Very light" gate | Adjusts the system which controls the motor force in order to adapt it to the weight of the gate. |
| | | L2 | "Light" gate | |
| | | L3 | "Average" gate | |
| | | L4 | "Average-heavy" gate | |
| | | L5 | "Heavy" gate | |
| | | L6 | "Very heavy" gate | |
| L6 | Open Partially | L1 | 0,5 m | Adjusts the measurement of the partial opening. Partial opening can only be controlled using the 2nd radio control (see Tables 4 and 5) |
| | | L2 | 1 m | |
| | | L3 | 1,5 m | |
| | | L4 | 2 m | |
| | | L5 | 2,5 m | |
| | | L6 | 3 m | |

Note: "■" represents the factory setting.

All the parameters can be adjusted as required without any contraindication; only the adjustment of the “motor force” could require special care:





- Do not use high force values to compensate for points of abnormal friction on the leaf. Excessive force can compromise the operation of the safety system or damage the leaf.

- If the “motor force” control is used to assist the impact force reduction system, measure the force again after each adjustment in compliance with EN standard 12445.

- Wear and weather conditions may affect the movement of the gate, therefore periodic re-adjustments may be necessary.

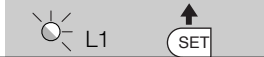
7.2.4) Level two programming (adjustable parameters)

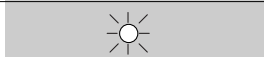
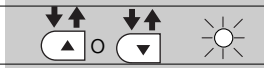





The adjustable parameters are factory set as shown in the table, with: “ ”. However, they can be changed at any time, as shown in Table 15. Follow the procedure carefully as there is a maximum time of 10 seconds between pressing one key and another. If more time lapses, the procedure will finish automatically and memorize the modifications made up to that stage.

| Table 15: changing the adjustable parameters | Example |
|--|--|
| 1. Press the key [Set] and hold it down (approx. 3 s) |  |
| 2. Release the [Set] key when L1 LED starts flashing |  |
| 3. Press keys [▲] or [▼] to move the flashing LED to the “input LED” which represents the parameter which is to be modified. |  |
| 4. Press the key [Set] and hold it down during step 5 and 6 |  |
| 5. Wait approx. 3 seconds, after which the LED representing the current level of the parameter which is to be modified will light up. |  |
| 6. Press keys [▲] or [▼] to move the LED which represents the parameter value. |  |
| 7. Release the key [Set] |  |
| 8. Wait 10 seconds before leaving the programme to allow the maximum time to lapse. |  |

Note: Points 3 to 7 can be repeated during the same programming phases in order to set other functions to ON or OFF.

7.2.5) Level one programming example (ON-OFF functions).









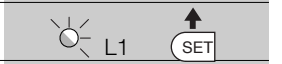

The sequence to follow in order to change the factory settings of the functions for activating “Automatic Closing” (L1) and “Always Close” (L3) have been included as examples.

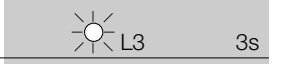
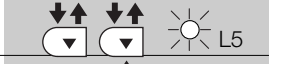
| Table 16: Level one programming example | Example |
|---|---|
| 1. Press the key [Set] and hold it down (approx. 3 s) |  |
| 2. Release the [Set] key when L1 LED starts flashing |  |
| 3. Press the [Set] key once to change the state of the function associated with L1 (Automatic Closing). LED L1 will now flash with long flashes. |  |
| 4. Press the [▼] key twice to move the flashing LED to LED L3. |  |
| 5. Press the [Set] key once to change the state of the function associated with L3 (Always Close). LED L3 will now flash with long flashes. |  |
| 6. Wait 10 seconds before leaving the programme to allow the maximum time to lapse. |  |

Once these operations have been completed, LEDs L1 and L3 must remain on to indicate that the “Automatic Closing” and “Always Close” functions are active.

7.2.6) Level two programming example (adjustable parameters)

The sequence to follow in order to change the factory settings of the parameters increasing the “Pause Time” to 60 seconds (input on L1 and level on L5), and lowering the “Motor Force” for light gates (input on L5 and level on L2) have been included as examples.

| Table 17: Level two programming example | Example |
|---|---|
| 1. Press the key [Set] and hold it down (approx. 3 s) |  |
| 2. Release the [Set] key when L1 LED starts flashing |  |
| 3. Press the key [Set] and hold it down during step 4 and 5 |  |
| 4. Wait approx. 3 seconds until LED L3, which represents the current level of the “Pause time”, switches on. |  |
| 5. Press the [▼] key twice to move the LED which is lit on to L5, which represents the new “Pause Time” value. |  |
| 6. Release the key [Set] |  |
| 7. Press the [▼] key 4 times to move the flashing LED to LED L5. |  |
| 8. Press the key [Set] and hold it down during step 9 and 10 |  |
| 9. Wait approx. 3 seconds until LED L5, which represents the current level of the “Motor Force”, switches on. |  |
| 10. Press the [▲] key 3 times to move the LED which is on to L2, which represents the new “Motor Force” value. |  |
| 11. Release the key [Set] |  |
| 12. Wait 10 seconds before leaving the programme to allow the maximum time to lapse. |  |

7.3) Adding or Removing Devices

Devices can be added to or removed from the ROBUS350 automation system at any time. In particular, various devices types can be connected to “BLUEBUS” and “STOP” input as explained in

paragraphs “7.3.1 BlueBUS” and “7.3.2 STOP Input”.

7.3.1) BlueBUS

BlueBUS technology allows you to connect compatible devices using only two wires which carry both the power supply and the communication signals. All the devices are connected in parallel on the 2 wires of the BlueBUS itself. It is not necessary to observe any polarity; each device is individually recognized because a univocal address is assigned to it during the installation. Photocells, safety devices, control keys, signalling lights etc. can be connected to BlueBUS. The ROBUS350 control unit recognizes all the connected devices individually through a suitable recognition process,

and can detect all the possible abnormalities with absolute precision. For this reason, each time a device connected to BlueBUS is added or removed the control unit must go through the recognition process; see paragraph 7.2.4 “Recognition of Other Devices”.

7.3.2) STOP Input

STOP is the input that causes the immediate interruption of the manoeuvre (with a short reverse run). Devices with output featuring normally open “NO” contacts and devices with normally closed “NC” contacts, as well as devices with 8.2KΩ constant resistance output, like sensitive edges, can be connected to this input.

During the recognition stage the control unit, like BlueBUS, recognizes the type of device connected to the STOP input (see paragraph 7.2.4 “Recognition of Other Devices”); subsequently it commands a STOP whenever a change occurs in the recognized status. Multiple devices, even of different type, can be connected to the STOP input if suitable arrangements are made.

- Any number of NO devices can be connected to each other in parallel.
- Any number of NC devices can be connected to each other in series.

- Two devices with 8.2KΩ constant resistance output can be connected in parallel; if needed, multiple devices must be connected “in cascade” with a single 8.2KΩ termination resistance
- It is possible to combine Normally Open and Normally Closed by making 2 contacts in parallel with the warning to place an 8.2 KΩ resistance in series with the Normally Closed contact (this also makes it possible to combine 3 devices: Normally Open, Normally Closed and 8.2 KΩ).

⚠ if the STOP input is used to connect devices with safety functions, only the devices with 8.2KΩ constant resistance output guarantee the fail-safe category 3 according to EN standard 954-1.

7.3.3) Photocells

By means of addressing using special jumpers, the “BlueBUS” system enables the user to make the control unit recognise the photocells and assign them with a correct detection function. The addressing operation must be done both on TX and RX (setting the jumpers in the same way) making sure there are no other couples of photocells with the same address. In an automation for sliding gates, with ROBUS350 it is possible to install the photocells as shown in Figure 22. After the installation or removal of photocells, the recognition phase in the control unit as described in Paragraph “7.3.4 Recognition of other devices” must be carried out.

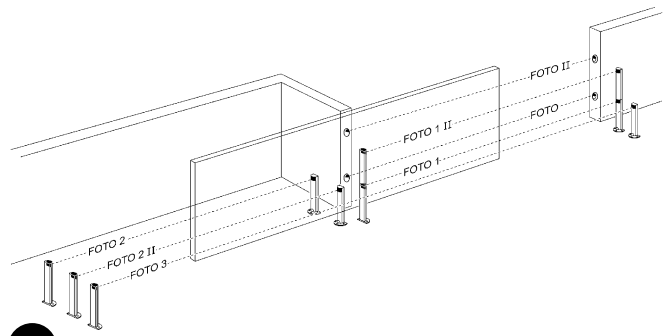

22

Table 18: Photocell addressing

| Photocell | Jumpers | Photocell | Jumpers |
|---|---------|---|---------|
| FOTO External photocell h=50cm; activated when gate closes | | FOTO 2 External photocell activated when gate opens | |
| FOTO II External photocell h=100cm; activated when gate closes | | FOTO 2 II Internal photocell activated when gate opens | |
| FOTO 1 Internal photocell h=50; activated when gate closes | | FOTO 3 Single photocell for the entire automation system | |
| FOTO 1 II Internal photocell h=100; activated when gate closes | | <p>⚠ In the case of the installation of FOTO 3 and FOTO II together the position of the photocell elements (TX-RX) must comply with the provisions contained in the photocell instruction manual</p> | |

7.3.4) Recognition of other devices

Normally the recognition of the devices connected to the BlueBUS and the STOP input takes place during the installation stage. However, if new devices are added or old ones removed, the recognition process can be gone through again by proceeding as follows:

Table 19: Recognition of Other Devices

| | |
|--|--------------------|
| 1. Press keys [▲] and [Set] and hold them down | Example |
| 2. Release the keys when L1 and L2 LED's start flashing very quickly (after approx. 3 s) | |
| 3. Wait a few seconds for the control unit to finish recognizing the devices | |
| 4. When the recognition stage is completed L1 and L2 LED's will go off, the STOP LED must remain on, while L2...L6 LED's will light up according to the status of the relative ON-OFF functions | |

⚠ After you have added or removed any devices, the automation system must be tested again according to the directions contained in paragraph 5.1 “Testing”.

7.4) Special Functions

7.4.1) “Always open” Function

The “Always open” function is a control unit feature which enables the user to control an opening manoeuvre when the “Step-by-Step” command lasts longer than 2 seconds. This is useful for connecting a timer contact to the “Step-by-Step” terminal in order to keep the

gate open for a certain length of time, for example. This feature is valid with any kind of “Step-by-Step” input programming, except for “Close”. Please refer to the “Step-by-Step Function” parameter in Table 14.

7.4.2) “Move anyway” function

In the event that one of the safety devices is not functioning properly or is out of use, it is still possible to command and move the gate in “Man present” mode. Please refer to the Paragraph “Control with

safety devices out of order” in the enclosure “Instructions and Warnings for users of the ROBUS gearmotor” for further information.

7.5) Connection to other devices

If the user needs to feed external devices such as a proximity reader for transponder cards or the illumination light of the key-operated selector switch, it is possible to tap power as shown in Figure 23.

The power supply voltage is 24Vdc -30% - +50% with a maximum available current of 100mA..

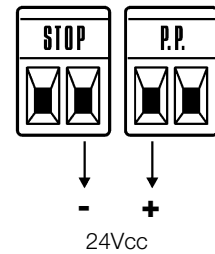

23

7.6) Troubleshooting

The table 20 contains instructions to help you solve malfunctions or errors that may occur during the installation stage or in case of failure.

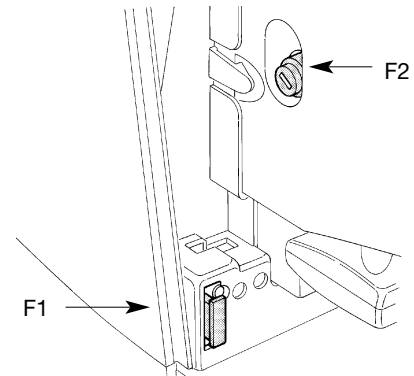

24

Table 20: Troubleshooting

| Symptoms | Recommended checks |
|--|--|
| The radio transmitter does not control the gate and the LED on the transmitter does not light up | Check to see if the transmitter batteries are exhausted, if necessary replace them. |
| The radio transmitter does not control the gate but the LED on the transmitter lights up | Check the transmitter has been memorised correctly in the radio receiver. |
| The user is unable to command manoeuvres and the "BLUEBUS" LED fails to flash. | Check that ROBUS350 is being fed 230V voltage from the power supply. Check to see if any fuses have blown. If necessary, identify the reason for the failure and then replace the fuses with others having the same current rating and characteristics. |
| No manoeuvre starts and the flashing light is off | Make sure that the command is actually received. If the command reaches the STEP-BY-STEP input, the corresponding "STEP-BY-STEP" LED must light up; if you are using the radio transmitter, the "BlueBus" LED must make two quick flashes. |
| No manoeuvre starts and the flashing light flashes a few times | Count the flashes and check the corresponding value in table 21 |
| The manoeuvre starts but it is immediately followed by a reverse run | The selected force could be too low for this type of gate. Check to see whether there are any obstacles; if necessary increase the force |
| The manoeuvre is carried out but the flashing light does not work | Make sure that there is voltage on the flashing light's FLASH terminal during the manoeuvre (being intermittent, the voltage value is not important: approximately 10-30Vac); if there is voltage, the problem is due to the lamp; in this case replace the lamp with one having the same characteristics; if there is no voltage, there may have been an overload on the FLASH output. Check that the cable has not short-circuited. |
| The manoeuvre is carried out but the Open Gate Indicator does not work | Check the type of function programmed for the S.C.A. output (Table 14). When the light should be on, check there is voltage on the S.C.A. terminal (approximately 24Vdc). If there is voltage, then the problem will have been caused by the light, which will have to be replaced with one with the same characteristics. If there is no voltage, there may have been an overload on the S.C.A. output. Check that the cable has not short-circuited. |

7.7) Diagnostics and Signals

A few devices issue special signals that allow you to recognize the operating status or possible malfunctions.

7.7.1) Flashing light signalling

During the manoeuvre the flashing light FLASH flashes once every second. When something is wrong the flashes are more frequent; the light flashes twice with a second's pause between flashes..

Table 21: FLASH flashing light signalling

| Quick flashes | Cause | ACTION |
|--|--|--|
| 1 flash 1 second's pause 1 flash | BlueBUS error | At the starting of the manoeuvre, the devices connected to BLUEBUS do not correspond to those recognized during the recognition phase. One or more devices may be faulty; check and, if necessary, replace them; in case of modifications repeat the recognition process (7.3.4 Recognition of Other Devices). |
| 2 flashes 1 second's pause 2 flashes | Triggering of a photocell | At the starting of the manoeuvre, one or more photocells do not enable it; check to see if there are any obstacles. This is normal when there is an obstacle impeding the movement. |
| 3 flashes 1 second's pause 3 flashes | Activation of the "motor force" limiting device | During the movement, the gate experienced excessive friction; identify the cause |
| 4 flashes 1 second's pause 4 flashes | Activation of the STOP input | During the movement the STOP input was activated; identify the cause |
| 5 flashes 1 second's pause 5 flashes | Error in the internal parameters of the electronic control unit. | Wait at least 30 seconds, then try giving a command. If nothing happens there may be a serious fault and the electronic card will have to be replaced. |
| 6 flashes 1 second's pause 6 flashes | The maximum manoeuvre limit/hour has been exceeded. | Wait for a few minutes until the manoeuvre limiting device drops to under the maximum limit. |
| 7 flashes 1 second's pause 7 flashes | There is an error in the internal electric circuits. | Disconnect all the power circuits for a few seconds and then try to give the command again. If nothing happens there may be a serious fault and the electronic card will have to be replaced. |

7.7.2) Signals on the control unit

On the ROBUS350 control unit there is a set of LED's each of which can give special indications both during normal operation and in case of malfunctions.

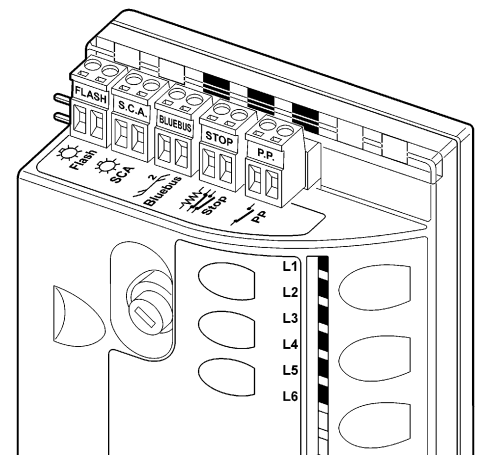

Table 22: LED's on the control unit's terminals

| BLUEBUS LED | Cause | ACTION |
|---|--------------------------------------|---|
| Off | Malfunction | Make sure there is power supply; check to see if the fuses are blown; if necessary, identify the reason for the failure and then replace the fuses with others having the same characteristics. |
| On | Serious malfunction | There is a serious malfunction; try switching off the control unit for a few seconds; if the condition persists it means there is a malfunction and the electronic board has to be replaced |
| One flash every second | Everything OK | Normal operation of control unit |
| 2 Quick flashes | The status of the inputs has changed | This is normal when there is a change in one of the inputs: OPEN, STOP, triggering of photocells or the radio transmitter is used |
| Series of flashes separated by a second's pause | Miscellaneous | It corresponds to the flashing light's signal. See Table 21 |
| STOP LED | Cause | ACTION |
| Off | Activation of the STOP input | Check the devices connected to the STOP input |
| On | Everything OK | STOP Input active |
| STEP-BY-STEP LED | Cause | ACTION |
| Off | Everything OK | STEP-BY-STEP input not active |
| On | Activation of the STEP-BY-STEP input | This is normal if the device connected to the STEP-BY-STEP input is actually active |

Table 23: LED's on the control unit's keys

| Led 1 | Description |
|----------|---|
| Off | During normal operation the device indicates "Automatic Closure" is inactive. |
| On | During normal operation the device indicates "Automatic Closure" is active. |
| Flashing | <ul style="list-style-type: none"> Function programming in progress If it flashes together with L2, it means that it the user must carry out the device recognition phase (refer to Paragraph "4.3 Recognition of the devices"). |
| Led L2 | Description |
| Off | During normal operation the device indicates "Close after photo" is inactive. |
| On | During normal operation the device indicates "Close after photo" is active. |
| Flashing | <ul style="list-style-type: none"> Function programming in progress If it flashes together with L2, it means that it the user must carry out the device recognition phase (refer to Paragraph "4.3 Recognition of the devices"). |
| Led L3 | Description |
| Off | During normal operation the device indicates "Always Close" is inactive. |
| On | During normal operation the device indicates "Always Close" is active. |
| Flashing | <ul style="list-style-type: none"> Function programming in progress If it flashes together with L4, it means that it the user must carry out the leaf length recognition phase (refer to Paragraph "4.4 Recognition length of the leaf"). |
| Led L4 | Description |
| Off | During normal operation the device indicates "Stand-By" is inactive. |
| On | During normal operation the device indicates "Stand-by" is active. |
| Flashing | <ul style="list-style-type: none"> Function programming in progress If it flashes together with L3, it means that it the user must carry out the length of the leaf recognition phase (refer to Paragraph "4.4 Recognition of the length of the leaf"). |
| Led L5 | Description |
| Off | During normal operation the device indicates "Thrust" is inactive. |
| On | During normal operation the device indicates "Thrust" is active. |
| Flashing | Function programming in progress. |
| Led L6 | Description |
| Off | During normal operation the device indicates "pre-flashing" is inactive. |
| On | During normal operation the device indicates "pre-flashing" is active. |
| Flashing | Function programming in progress. |

7.8) Accessories

The following optional accessories are available for ROBUS350:

- PS124 24 V Buffer battery – 1.2Ah with integrated charger battery

For information on the complete range of accessories, refer to the Nice s.p.a. product catalogue.

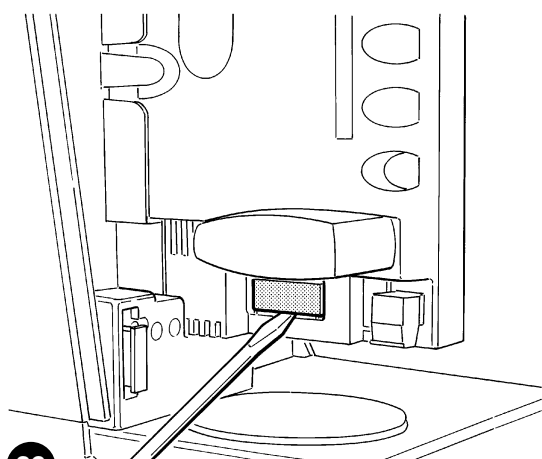

26

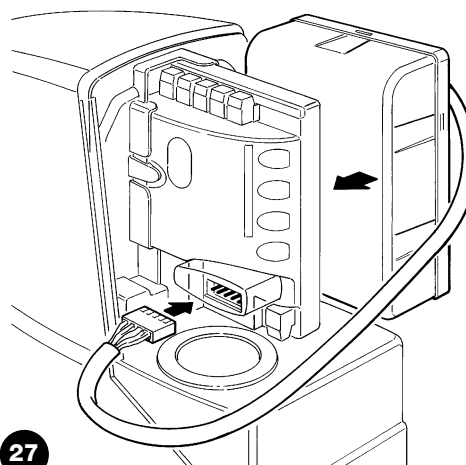

27

8) Technical characteristics

Nice S.p.a., in order to improve its products, reserves the right to modify their technical characteristics at any time without prior notice. In any case, the manufacturer guarantees their functionality and fitness for the intended purposes.

All the technical characteristics refer to a room temperature of 20°C (±5°C).

| Technical characteristics: ROBUS350 | |
|---|---|
| Type | Electromechanical gearmotor for the automatic movement of sliding gates for residential use, complete with electronic control unit. |
| Pinion | Z: 15; Module: 4; Pitch: 12,6mm; Pitch diameter: 60mm |
| Peak thrust | 18Nm; corresponds to the ability to start a leaf with a static friction of max. 600N moving. |
| Nominal torque | 10Nm; corresponds to the ability to keep a leaf with a dynamic friction max. 333N moving. |
| Nominal torque speed | 0,18m/s |
| Idling speed | 0,34m/s |
| Maximum frequency of operating cycles | 50 cycles per day (the control unit allows up to the maximum described in tables 1 and 2) |
| Maximum continuous operating time | 10 minutes (the control unit limits the continuous operation up to the maximum described in tables 1 and 2) |
| Operating limits | In general, ROBUS350 is suitable for the automation of gates featuring leaves up to 15 m wide and weighing up to 350 kg, as shown in Tables 1 and 2. |
| ROBUS350 Power supply | 230Vac (+10% +15%) 50/60Hz. |
| ROBUS350/V1 Power supply | 120Vac (+10% +15%) 50/60Hz. |
| Max. absorbed power | 250VA |
| Insulation class | 1 (a safety grounding system is required) |
| Emergency power supply | With PS124 optional accessory |
| Flashing Light Output | For 1 LUCYE flashing light (12V, 21 W lamp) |
| BLUEBUS Output | One output with a maximum load of 15 BlueBus units |
| STOP Input | For normally open contacts, for 8.2KΩ constant resistance, or normally closed contacts; with self-recognition (any variation from the memorized status causes the "STOP" command) |
| Step-by-step Input | For normally open contacts (the closing of the contact causes the "STEP-BY-STEP" command) |
| Radio AERIAL Input | 52 Ω for RG58 or similar type of cable |
| Programmable functions | 6 ON-OFF functions and 6 adjustable functions (see tables 12 and 14) |
| Recognition functions | Recognition of the devices connected up to the BlueBUS output. Recognition of the type of "STOP" device (Normally Open or Normally Closed contact or 8.2KΩ resistance). Recognition of the length of the gate and calculation of the slowdown and partial opening points. |
| Operating temperature | -20°C ÷ 50°C |
| Use in acid, saline or potentially explosive atmosphere | No |
| Protection class | IP 44 |
| Dimensions and weight | 330 x 195 h 227; 8Kg |

| Technical characteristics | Radio receiver: SMXI | Radio receiver: SMXIS |
|----------------------------------|---|---|
| Type | 4 channel receiver for radio control devices. | |
| Frequency | 433.92MHz | |
| Coding | Digital Rolling code with 53 Bit code, FLOR type | Digital Rolling code with 64 Bit code, SMILO type |
| Transmitter compatibility | FLOR, VERY VR; only single group: ERGO, PLANO, PLANOTIME, SMILO | SMILO |
| Transmitters memorized | Up to 256 if memorized in mode 1 | |
| Input impedance | 52Ω | |
| Sensitivity | better than 0.5μV | |
| Range of the transmitters | From 100 to 150 m. The range can vary if there are obstacles or electromagnetic disturbances, and is affected by the position of the receiving aerial | |
| Outputs | 4 (on SM connector) | |
| Operating temperature | -10°C ÷ 55°C | |

| Technical characteristics | transmitter: FLO2R-S | transmitter: SM2 |
|----------------------------------|--|---|
| Type | 2 channel transmitter for radio command | |
| Frequency | 433.92MHz | |
| Coding | Digital Rolling code with 53 Bit code, FLOR type | Digital Rolling code with 64 Bit code, SMILO type |
| Buttons | 2 | |
| Power supply | 12Vdc with 23A battery | |
| Absorption | 25mA | |
| Battery life | 1 year, estimated on the basis of 10 commands/day, each lasting 1s at 20°C (at low temperatures the efficiency of the batteries decreases) | |
| Irradiated power | 100μW | |
| Dimensions and weight | 72 x 40 h 18mm / 30g | Diameter 48 h14mm / 19g |
| Protection class | IP40 (suitable for use indoors or in protected environments) | |
| Operating temperature | -40°C ÷ 85°C | |

Congratulations for having chosen a Nice product for your automation system! Nice S.p.A. produces components for the automation of gates, doors, rolling gates, roller shutters and awnings: gearmotors, control units, radio controls, flashing lights, photocells and miscellaneous accessories. Nice uses only the finest materials and first-class workmanship. It focuses on the development of innovative solutions designed to simplify the use of its equipment, dedicating meticulous care to the study of its technical, aesthetic and ergonomic characteristics: From the wide range of Nice products, your installation technician will certainly have selected the one best suited to your specific requirements. However, Nice is not the producer of your automation system, which is rather the result of a combination of operations carried out by your installation technician, namely analysis, evaluation, selection of materials and system implementation. Each automation system is unique. Your installation technician is the only person who possesses the experience and professionalism needed to set up a system capable of satisfying your requirements, a system that is safe, reliable, long lasting and built in accordance with the regulations in force. An automation system is not only very convenient; it also improves the level of security in your home. Moreover, it will last for years with very little maintenance. Even though the automation system you possess meets the safety requirements of the legislation in force, this does not exclude the existence of a "residual risk", i.e. the possibility that dangers may arise, usually as a result of improper or unreasonable use. We have prepared the following list of do's and don'ts to help you avoid any mishaps:

- **Before using your automation system** for the first time, ask the installer to explain the origin of any residual risks; take a few minutes and **read the users instructions manual given you by the installer.** Retain the manual for future use and deliver it to any subsequent owner of the automation system.

- **Your automation system is a machine that will faithfully execute your commands;** unreasonable or improper use may generate dangers: do not operate the system if there are people, animals or objects within its range of operation.

- **Children:** automation systems are designed to guarantee high levels of safety and security. They are equipped with detection devices that prevent movement if people or objects are in the way, guaranteeing safe and reliable activation. However, children should not be allowed to play in the vicinity of automated systems; to prevent any accidental activations, keep all remote controls away from children: **they are not toys!**

- **Malfunctions:** If you notice that your automation is not functioning properly, disconnect the power supply

to the system and operate the manual release device. Do not attempt to make any repairs; call the installation technician and, in the meantime, operate the system like a non-automatic gate after releasing the gearmotor as described below.

- **Maintenance:** Like any machine, your automation needs regular periodic maintenance to ensure its long life and total safety. Arrange a periodic maintenance schedule with your installation technician. Nice recommends that maintenance checks be carried out every six months for normal domestic use, but this interval may vary depending on the intensity of use. Only qualified personnel are authorized to carry out checks, maintenance operations and repairs.

- Do not modify the system or its programming and adjustment parameters in any way, even if you feel capable of doing it: your installation technician is responsible for the system.

- **The final test,** the periodic maintenance operations and any repairs must be documented by the person who has performed them; these documents must remain under the custody of the owner of the system.

The only recommended maintenance operations that the user can perform periodically concern the cleaning of the photocell glasses and the removal of leaves and debris that may impede the automation. To prevent anyone from activating the gate release the automation system (as described below). Use a slightly damp cloth to clean.

- **Disposal:** At the end of its useful life, the automation must be dismantled by qualified personnel, and the materials must be recycled or disposed of in compliance with the legislation locally in force.

- **In the event of malfunctions or power failures.** While you are waiting for the technician to come (or for the power to be restored if your system is not equipped with buffer batteries), you can operate the system like any non-automatic gate. In order to do this you need to manually release the gearmotor (this operation is the only one that the user of the automation is authorized to perform): This operation has been carefully designed by Nice to make it extremely easy, without any need for tools or physical exertion.



Manual movement and release: before carrying out this operation please note that release can only occur when the leaf is stopped.

1 Slide the lock cover disc

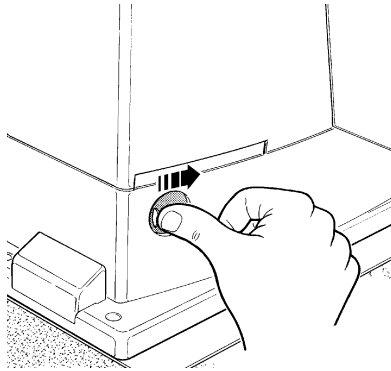

2 Insert and turn the key clockwise

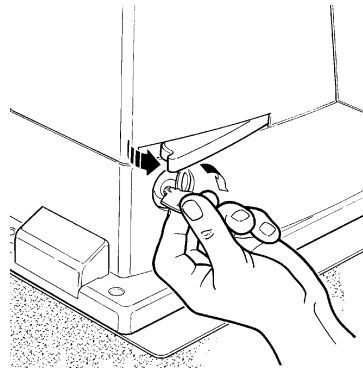

3 Pull the release handle

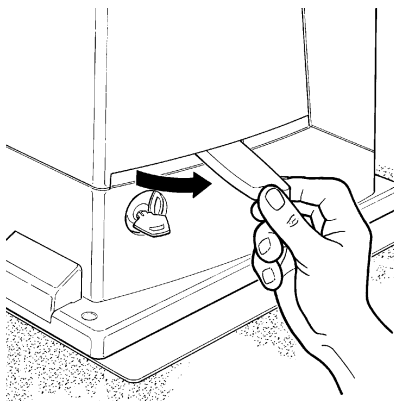

4 Move the leaf manually

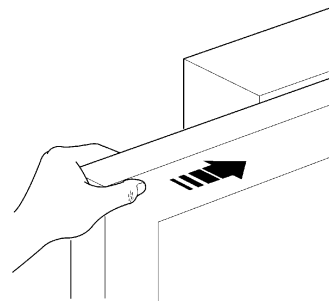

To lock: carry out the same procedures backwards.

Control with safety devices out of order: If the safety devices are malfunctioning, it is still possible to control the gate.

- Operate the gate control device (remote control or key-operated selector switch etc.). If the safety devices enable the operation, the gate will open and close normally, otherwise the flashing light flashes a few times but the manoeuvre does not start (the number of flashes depends on the reason why the manoeuvre is not enabled).
- In this case, **actuate** the control again within 3 seconds and **keep it actuated**.
- After approximately 2s the gate will start moving in the "man present" mode, i.e. so long as the control is maintained the gate will keep moving; as soon as the control is released the gate will stop.

⚠ If the safety devices are out of order the automation must be repaired as soon as possible.

Replacing the Remote Control Battery: if your radio control, after a period of time, seems not to work as well, or not to work at all, it may simply be that the battery is exhausted (depending on the type of use, it may last from several months up to one year and more). In this case you will see that the light confirming the transmission is weak, or does not come on, or comes on only briefly. Before calling the installation technician try exchanging the battery with one from another operating transmitter: if the problem is caused by a low battery, just replace it with another of the same type.

The batteries contain polluting substances: do not dispose of them together with other waste but use the methods established by local regulations.

Are you satisfied? If you wish to install another automation system in your home, call your old installation technician and use Nice products. You will get the services of a specialist and the most advanced products available on the market, superior performances and maximum system compatibility.

Thank you for reading these instructions. We feel confident that you will be well satisfied with your new system: for any present or future requirements, please contact your reliable installation technician.



COMPANY
WITH QUALITY SYSTEM
CERTIFIED BY DNV
=ISO 9001/2000=

 **Nice SpA**
Oderzo TV Italia
Tel. +39.0422.85.38.38
Fax +39.0422.85.35.85
info@niceforyou.com

 **Nice Padova**
Sarmeola di Rubano PD Italia
Tel. +39.049.89.78.93.2
Fax +39.049.89.73.85.2
info.pd@niceforyou.com

 **Nice Roma**
Roma Italia
Tel. +39.06.72.67.17.61
Fax +39.06.72.67.55.20
info.roma@niceforyou.com

 **Nice France**
Buchelay
Tel. +33.(0)1.30.33.95.95
Fax +33.(0)1.30.33.95.96
info@nicefrance.fr

 **Nice Rhône-Alpes**
Decines Charpieu France
Tel. +33.(0)4.78.26.56.53
Fax +33.(0)4.78.26.57.53
info.lyon@nicefrance.fr

 **Nice France Sud**
Aubagne France
Tel. +33.(0)4.42.62.42.52
Fax +33.(0)4.42.62.42.50
info.marseille@nicefrance.fr

 **Nice Belgium**
Leuven (Heverlee)
Tel. +32.(0)16.38.69.00
Fax +32.(0)16.38.69.01
info@nicebelgium.be

 **Nice España Madrid**
Tel. +34.9.16.16.33.00
Fax +34.9.16.16.30.10

 **Nice España Barcelona**
Tel. +34.9.35.88.34.32
Fax +34.9.35.88.42.49

 **Nice Polska**
Pruszków
Tel. +48.22.728.33.22
Fax +48.22.728.25.10
info@nice.com.pl

 **Nice China**
Shanghai
Tel. +86.21.525.706.34
Fax +86.21.621.929.88
info@niceforyou.com.cn

www.niceforyou.com

 **Nice Gate** is the doors and gate automation division of Nice

 **Nice Screen** is the rolling shutters and awnings automation division of Nice